

Auf welcher Seite ist mehr? Kreuze an!

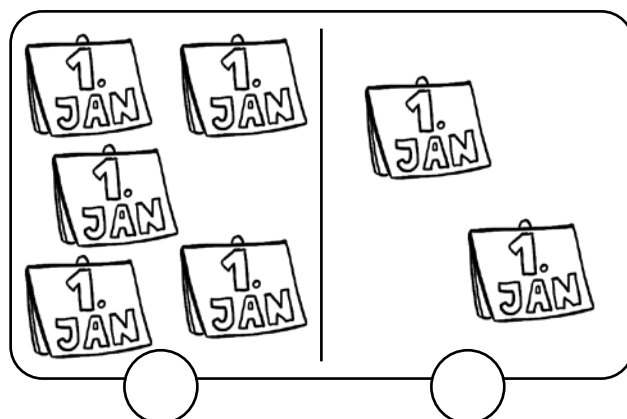

Auf welcher Seite ist weniger? Kreuze an!

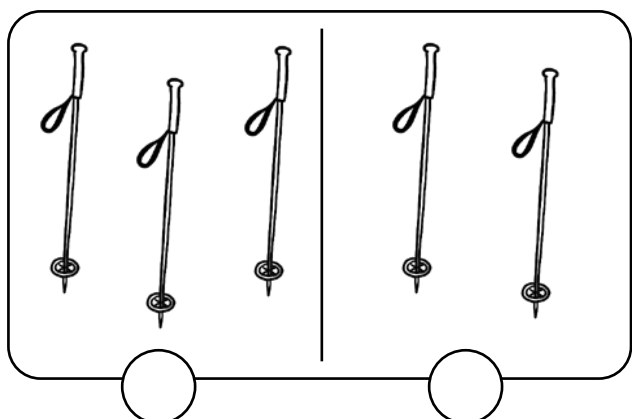
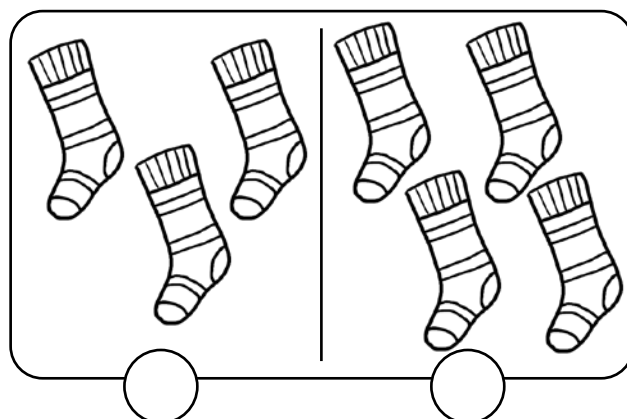
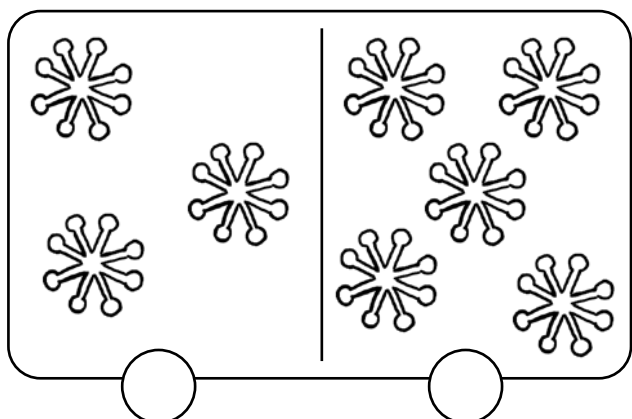
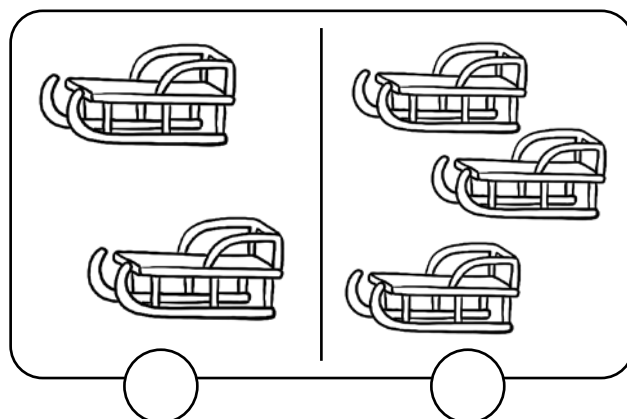
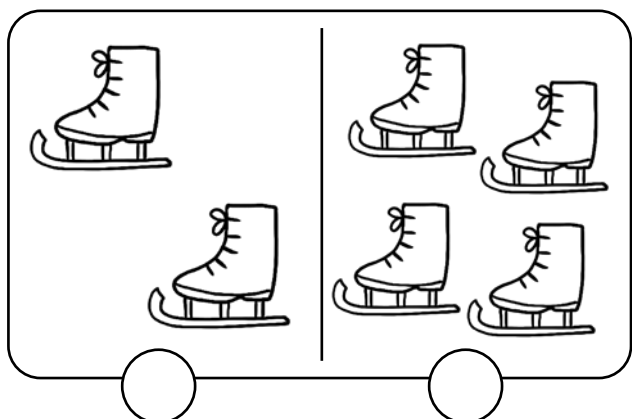
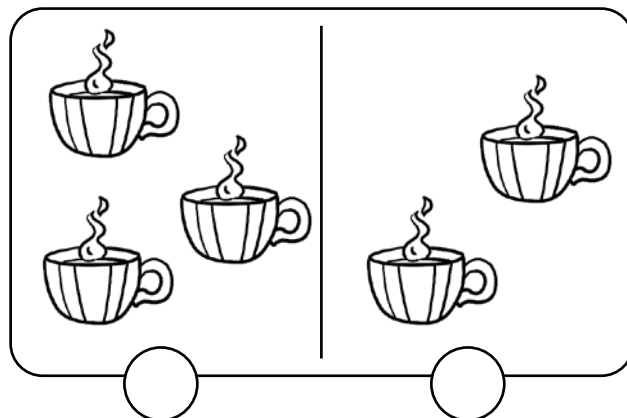
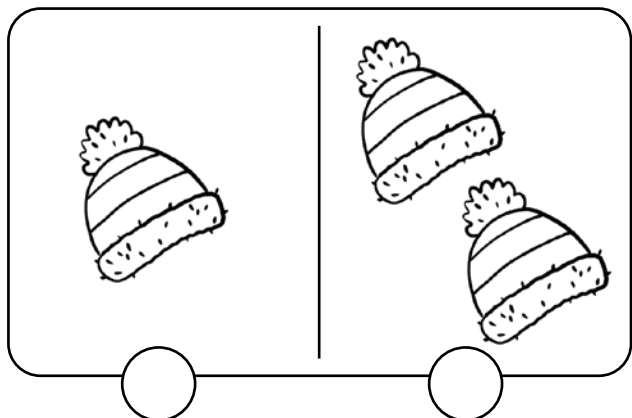
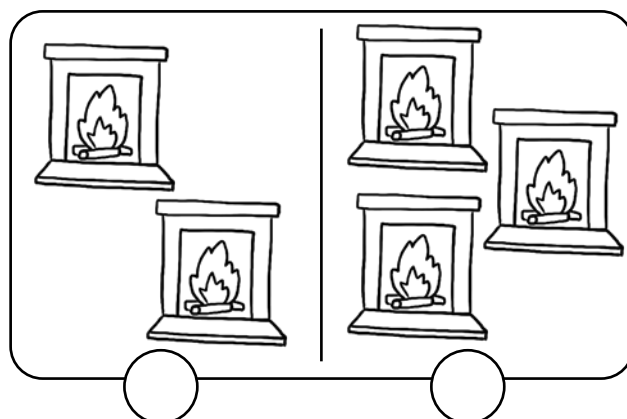
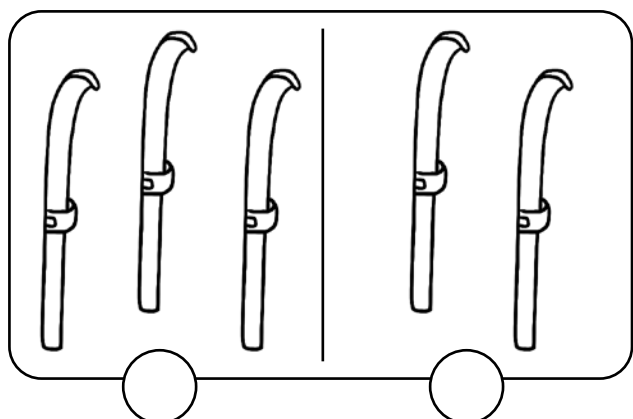
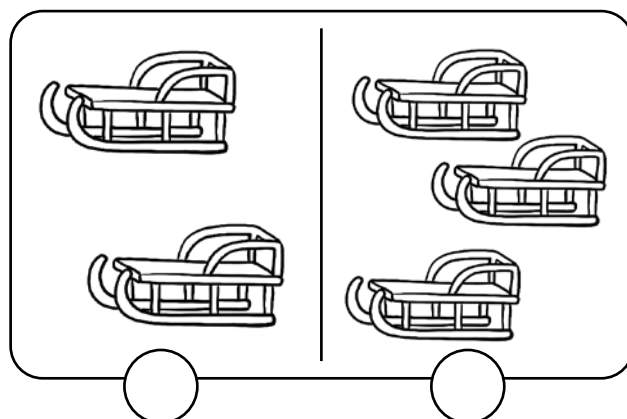
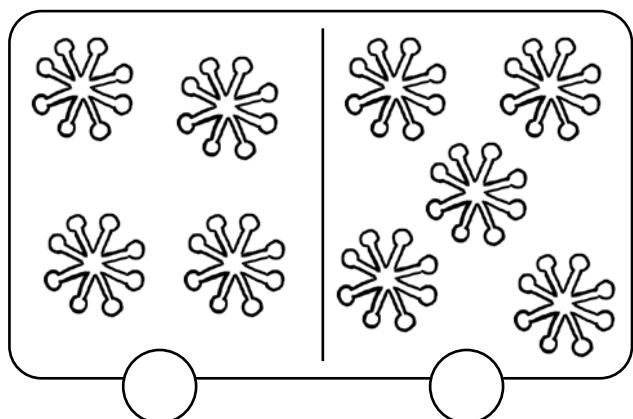
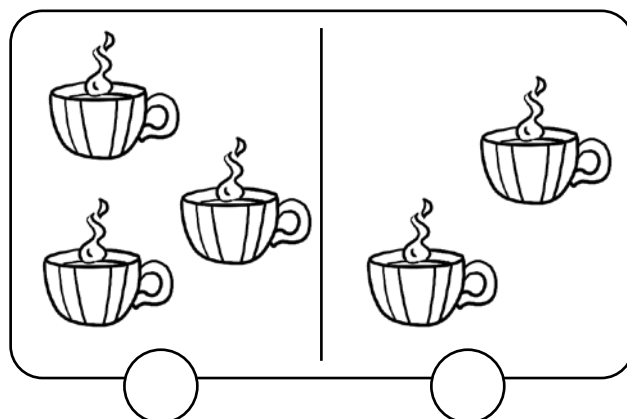
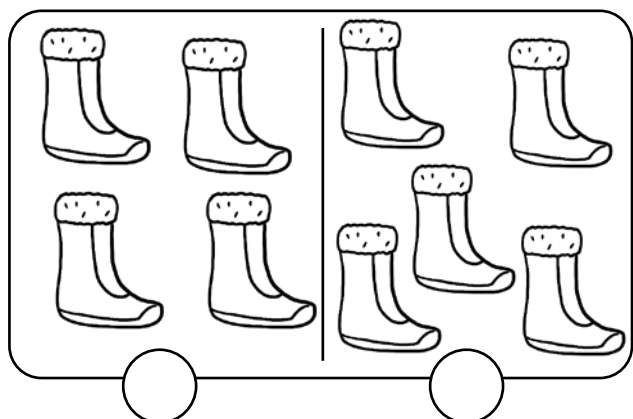
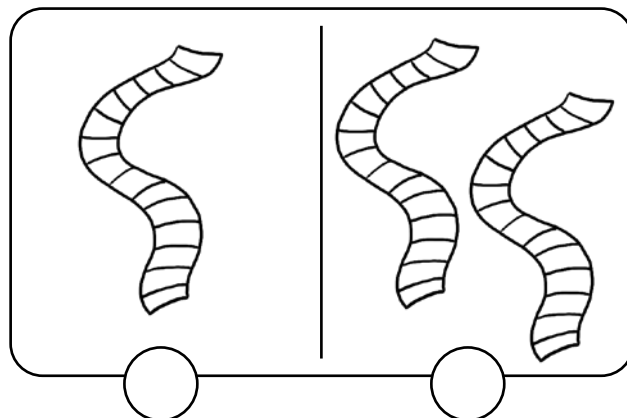
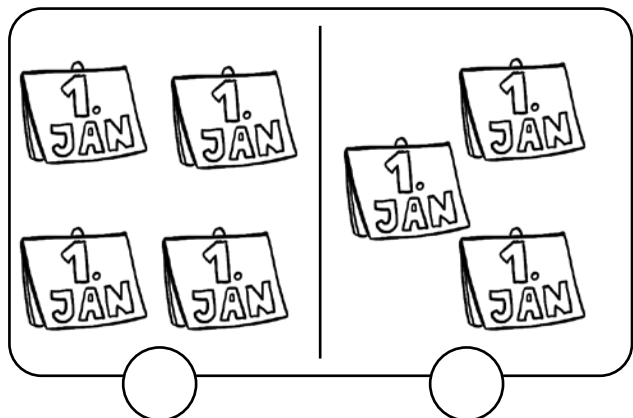

Male gleich viele Dinge an!

